

FUSION PAN DATASHEET

Technical Data

Thickness	All .87" in height
Handing	Universal (not handed)
Waste outlet position	Various, design to be rotated to avoid joists, pipework or other obstruction.
Trap Size	7.87" aperture in floor former
Waste options	Tile or Vinyl Drain.
Sizes Available	35"x35", 39"x39", 47"x47", 51"x32", 55"x35", 59"x32", 59"x32" end drain, 59"x47", 67"x33", 73"x35"
Cut to Length	Can be cut up to 2" on the perimeter.
Cut to length version 72.83" x 35.43"	Can be cut to Length to suit wall to wall measurement. When cut to length the cut edges must be fitted against a wall and supported on additional blocking or trimmers.
Construction	Multi Layer GRP with solid core and durable Polyester Gel outer surface.
Features	Creates reliable and consistent gradient for wet floor showers. Easy installation, no special skills required. Large range of floor drain options.
Installation	For installation with tile or slip resistant vinyl, it can be fixed directly to floor joists.
Supplied with	Wet Room Shower System, which includes Tile or Vinyl Drain, Liquid Waterproofing, Inside Corner Rubberized Crack Isolation Tape, Drain Gasket and Crack Isolation Tape. Also included are screws and installation guide.

Standard Fusion Pan - FP4747

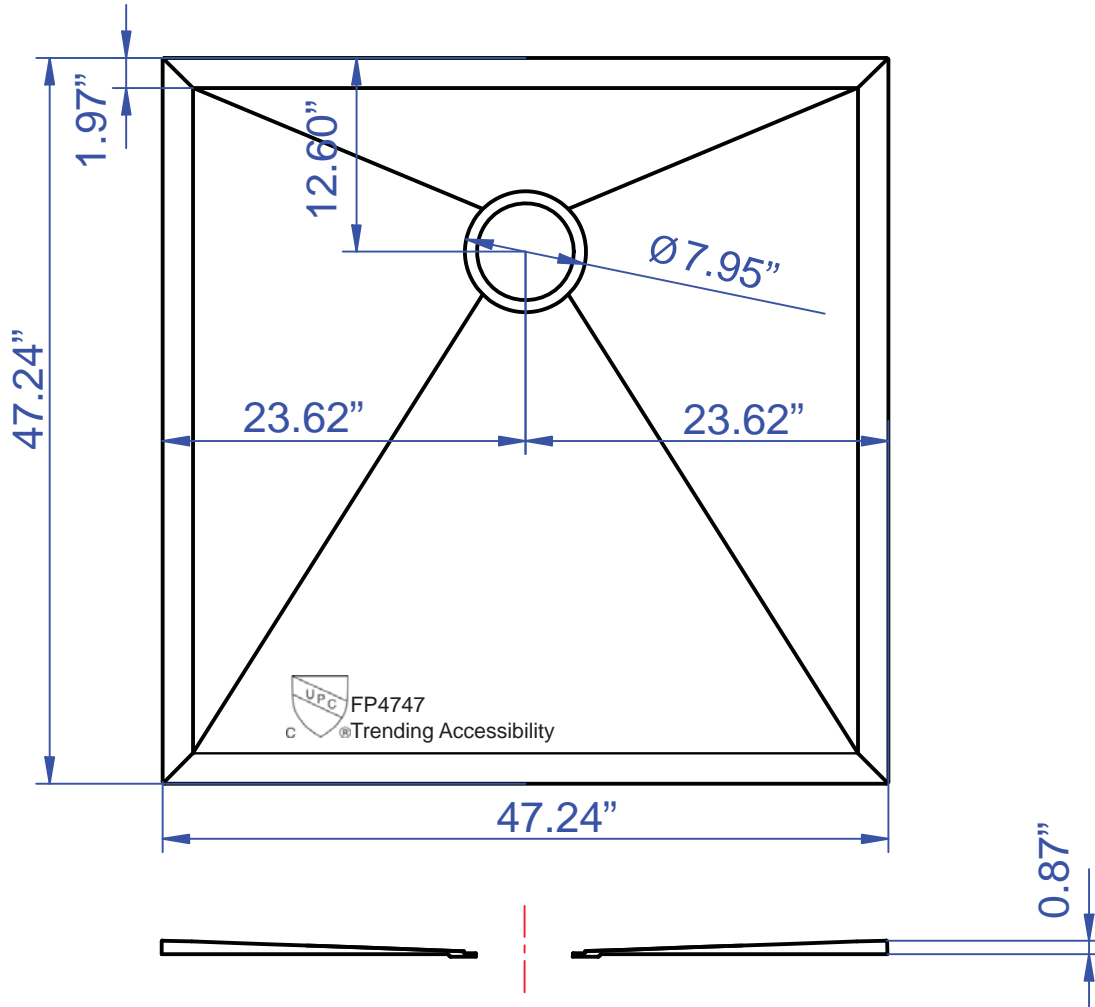

Trending Accessibility reserves the right to change the design or specification without prior notice. All dimensions are approximate.