

FUSION PAN DATASHEET

Technical Data

| | |
|--|---|
| Thickness | All .87" in height |
| Handing | Universal (not handed) |
| Waste outlet position | Various, design to be rotated to avoid joists, pipework or other obstruction. |
| Trap Size | 7.87" aperture in floor former |
| Waste options | Tile or Vinyl Drain. |
| Sizes Available | 35"x35", 39"x39", 47"x47", 51"x32", 55"x35", 59"x32", 59"x32" end drain, 59"x47", 67"x33", 73"x35" |
| Cut to Length | Can be cut up to 2" on the perimeter. |
| Cut to length version 72.83" x 35.43" | Can be cut to Length to suit wall to wall measurement. When cut to length the cut edges must be fitted against a wall and supported on additional blocking or trimmers. |
| Construction | Multi Layer GRP with solid core and durable Polyester Gel outer surface. |
| Features | Creates reliable and consistent gradient for wet floor showers. Easy installation, no special skills required. Large range of floor drain options. |
| Installation | For installation with tile or slip resistant vinyl, it can be fixed directly to floor joists. |
| Supplied with | Wet Room Shower System, which includes Tile or Vinyl Drain, Liquid Waterproofing, Inside Corner Rubberized Crack Isolation Tape, Drain Gasket and Crack Isolation Tape. Also included are screws and installation guide. |

Standard Fusion Pan - FP7335

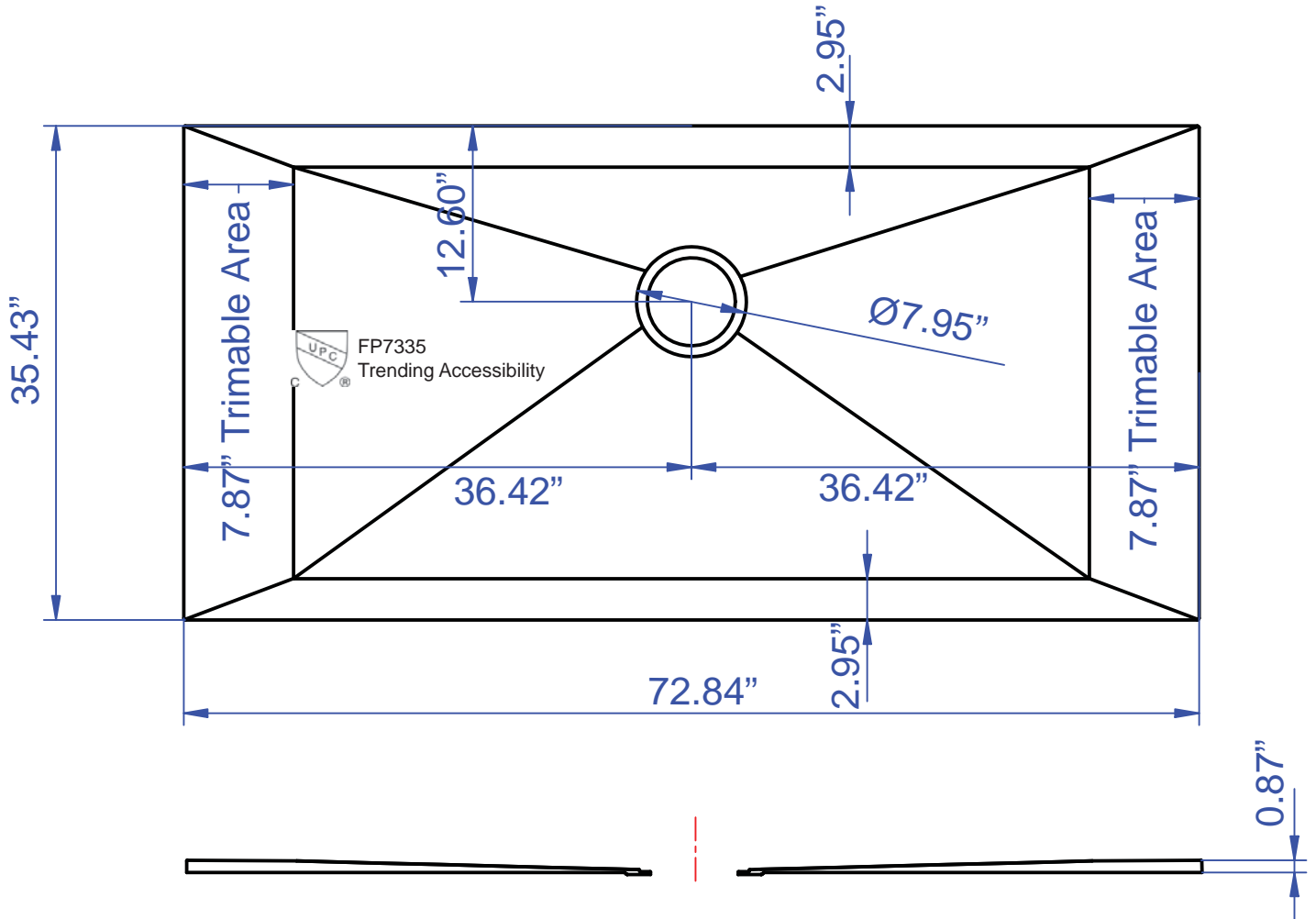

Trending Accessibility reserves the right to change the design or specification without prior notice. All dimensions are approximate.