

ADJUSTABLE FUSION PAN DATASHEET

Technical Data

Thickness	All 7/8" thick
Handing	Universal (not handed)
Waste outlet position	Adjustable, designed to be rotated to avoid joists, pipe work or other obstruction.
Waste options	Tile or Vinyl Drain.
Sizes available	35"x35", 39"x39", 47"x35", 47"x47", 51"x32", 55"x35", 59"x32", 59"x47", 67"x30"
Cut to length version (see diagrams page 4)	Can be cut to Length to suit wall to wall measurement or to accommodate pipes etc. When cut to length the cut edges must be fitted against a wall and supported on additional blocking.
Construction	Rigid GRP (glass fibre and polyester resin) composite with reinforcing ribs in underside to distribute loads evenly.
Features	Unique rotating drain plate allows floor drain to be positioned to avoid joists or other obstructions. 7/8" thick for easy installation into conventional wood floors. Consistent gradient (0.59"), Preformed countersunk screw holes, easily cut with a handsaw.
Installation	Can be installed directly onto floor joists (at 16" centers) with no under boarding or bedded into screeded floors.
Supplied with...	Wet Room Shower System, which includes... Tile or Vinyl Drain, Liquid Waterproofing, Inside Corner Rubberized Crack Isolation Tape, Drain Gasket and Crack Isolation Tape. Also included are screws and installation guide.

Adjustable Fusion Pan - FPA5947

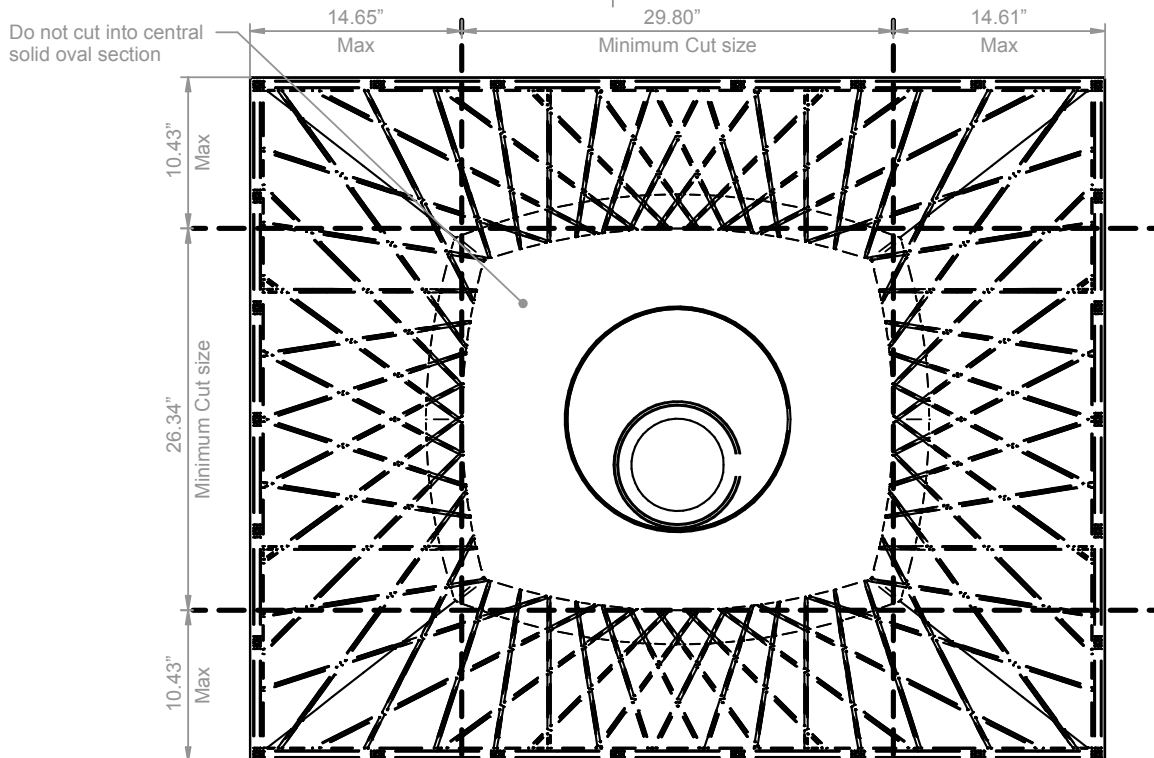
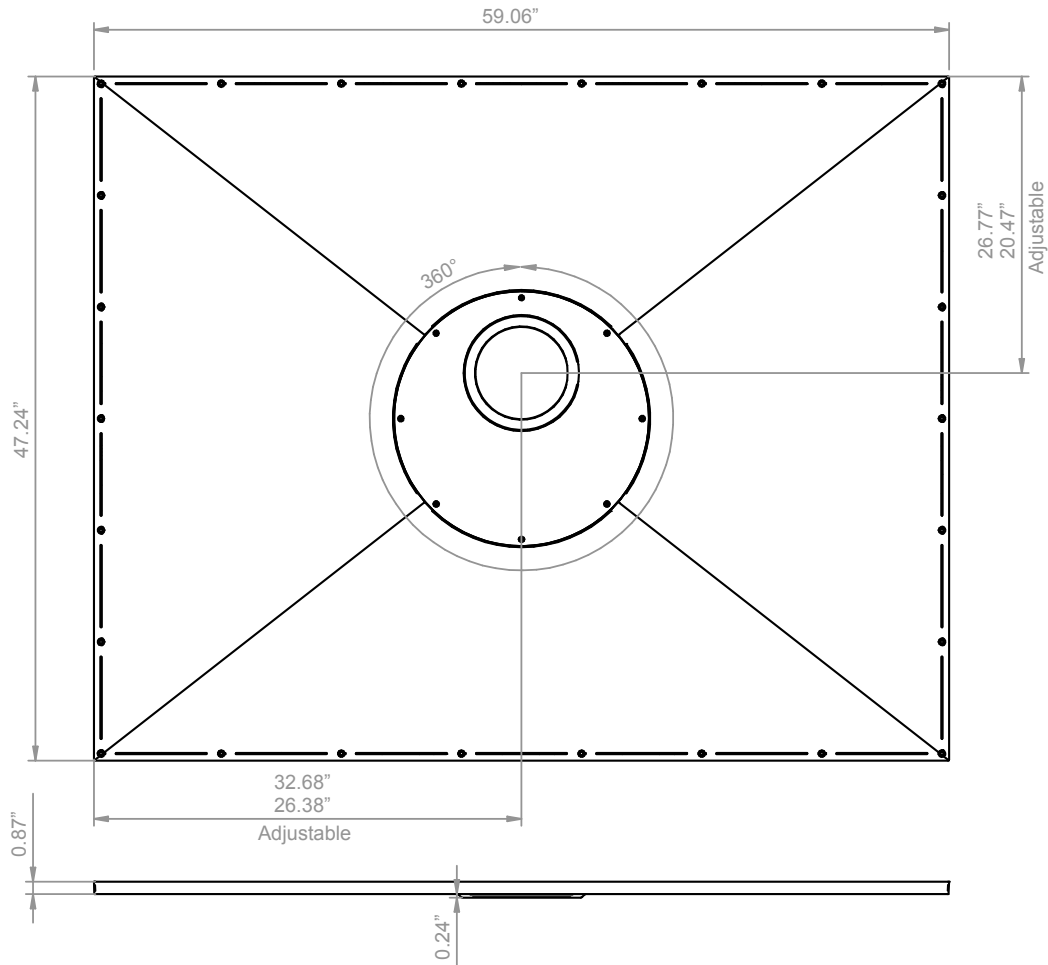

Adjustable Fusion Shower Pan - Cutting and Drilling guideline

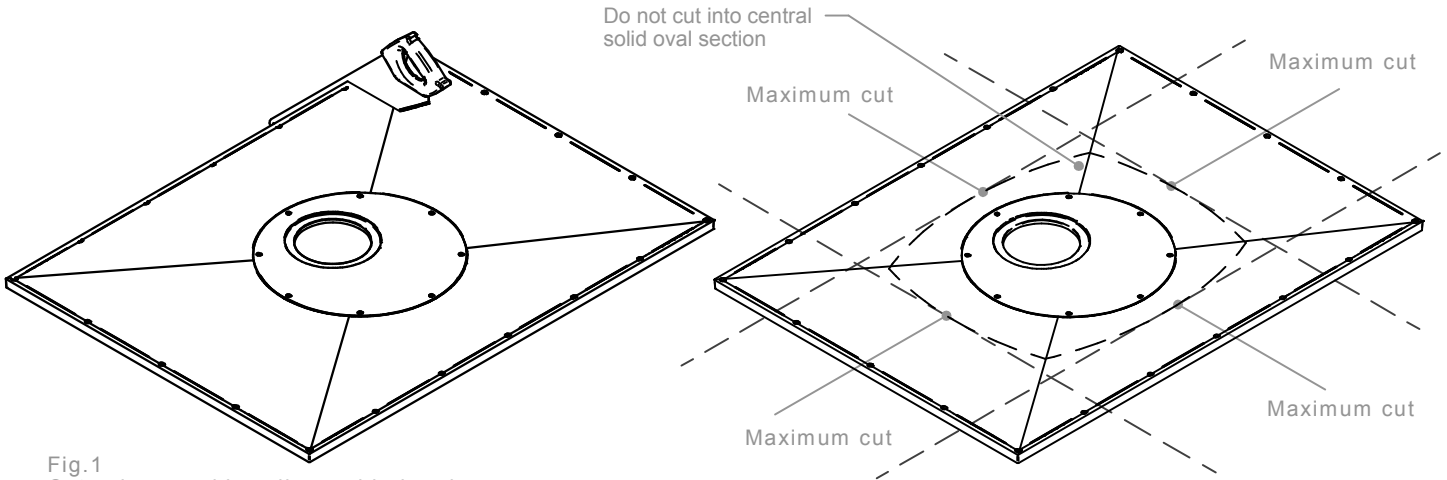

Fig.1
Cut using an old or disposable handsaw.

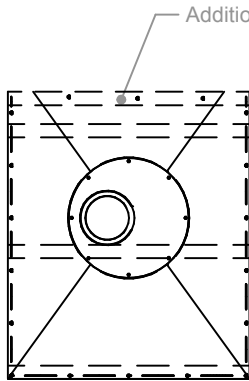

Fig.2
Cut to length.

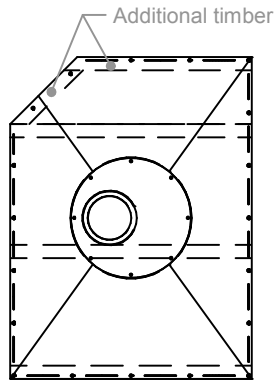

Fig.3
Cut to accommodate diagonal wall.

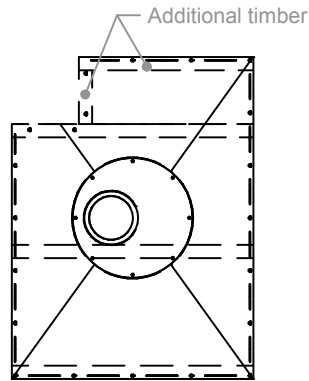

Fig.4
Cut to accommodate drain point.

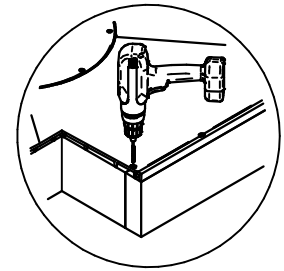

Fig.5
Ensure cut edges are fixed.

Ensure all the cut edges are supported, then drill, countersink and screw the Pan to the joists below in around 7.87" intervals (avoiding pipes, electric wires, etc.).

Important: Do not cut the edges that adjoin surrounding floor. Cutting the Pan may reduce flow rate performance.

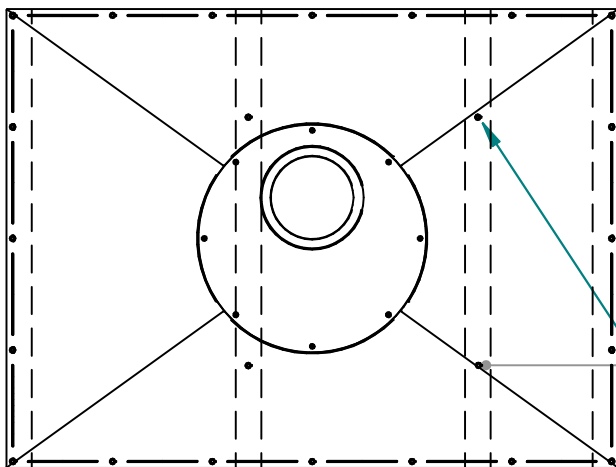

Fig.6
If Pan is not in contact with joist/concrete floor you must drill out and countersink the Pan to ensure it does. Failure to do this will allow unacceptable movement and may cause floor tiles to crack or become loose.

Additional fixing points