



Transitional Linear Drain Fusion Pan Technical Data

Thickness	All .87" in height
Handing	Universal (not handed)
Waste outlet position	Central x 8.66" from back edge
Outlet Size	2"
Sizes Available	39" x 39", 47" x 35", 47" x 47"
Construction	Multi Layer GRP with solid core and durable Polyester Gel outer surface.
Features	Creates reliable and consistent gradient for wet floor showers. Easy installation, no special skills required. Higher flow rates. Easier to tiles conventional floor formers
Installation	Only suitable for tiled floor finishes. Must be fully supported on the underside by minimum .71" thickness plywood. Must be installed with a suitable waterproofing floor membrane.
Supplied with	Tile edging kit for edges of drain (up to 0.39" thick tiles). Wet Room Shower System, which includes... Tile or Vinyl Drain, Liquid Waterproofing, Inside Corner Rubberized Crack Isolation Tape, Drain Gasket and Crack Isolation Tape. Also included are screws and installation guide.

Trending Accessibility reserves the right to change the design of specification without prior notice.
All values are approximate.

Transitional Linear Drain Fusion Pan - FPLT4735

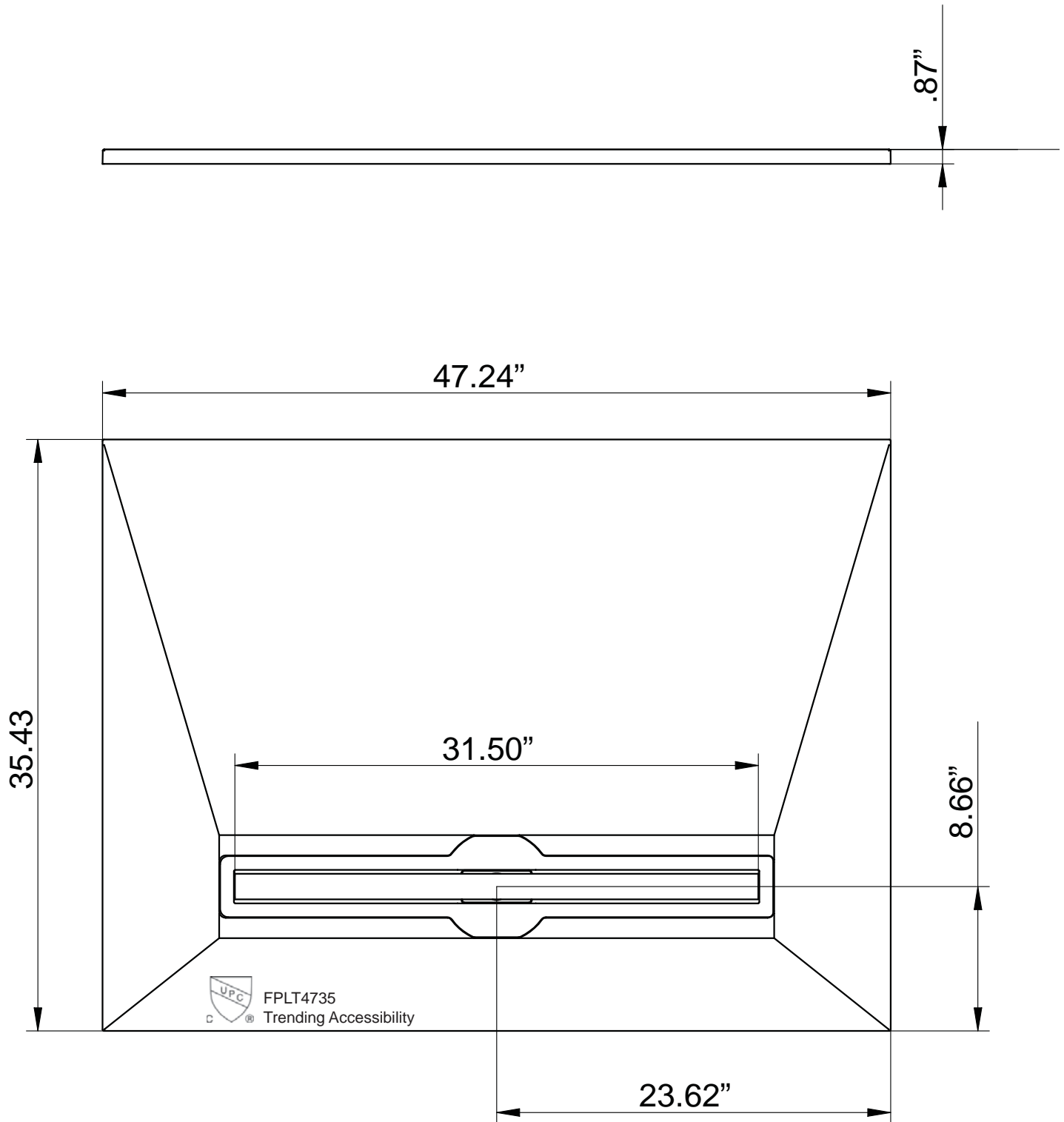

Trending Accessibility reserves the right to change the design or specification without prior notice.
All dimensions are approximate.