

- a) Wall
- b) Tile
- c) Shower Pan
- d) Liquid Membrane
- e) Crack Isolation Tape
- f) Concrete

fusion shower pan surface mounted on concrete installation guide

Required Components (included)

- a) Fusion Standard Shower Pan
 - b) Tile Drain
 - c) Liquid Waterproofing - 2 gallon bucket (covers approx. 100 sq ft with 2 coats)
 - d) Roll of Rubberized Crack Isolation Tape (100 ft)
 - e) 2 - Inside corners of Rubberized Crack Isolation Tape
 - f) Gasket Membrane
- 15 - 2 1/2" screws
4 - 3/4" screws



Note: If you have a larger room and need more waterproofing supplies, please contact us before completing your order.

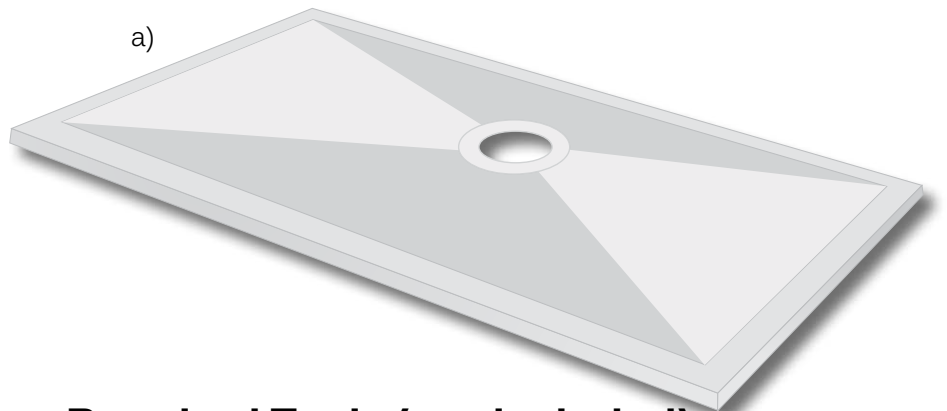

Required Tools (not included)



- Drill
- Concrete Saw
- Reciprocating Saw
- Level
- Square
- Caulk Gun
- Hammer
- Utility Knife or Scissors
- Tape Measure
- Paint Rollers
- Paint Brush
- Chisel
- Belt or Orbital Sander / Sandpaper
- Hammer Drill
- Latex or Acrylic Caulk (**DAP Dynaflex 230**)
- Concrete Anchors
- Splash Goggles
- Chemically resistant or impermeable gloves

..... for fusion shower pan surface mounted on concrete

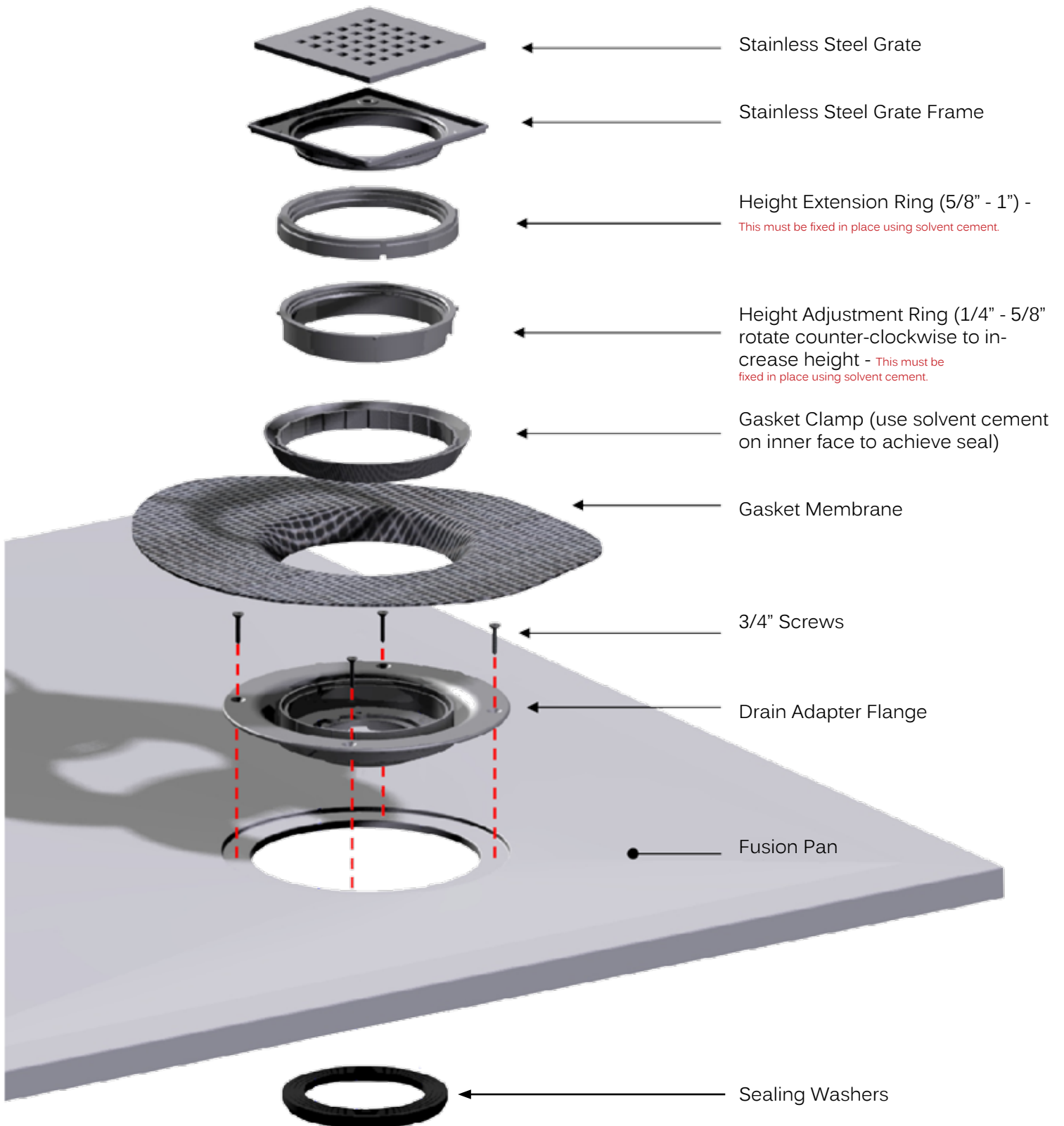

Step 1 > > > > > > >

For optimal performance, it is imperative there is a level surface prior to installation of new Fusion Pan. Check existing floor to make sure it is level. If it is not, please correct prior to installation. Place the Fusion pan in desired location and check to make sure it is level.

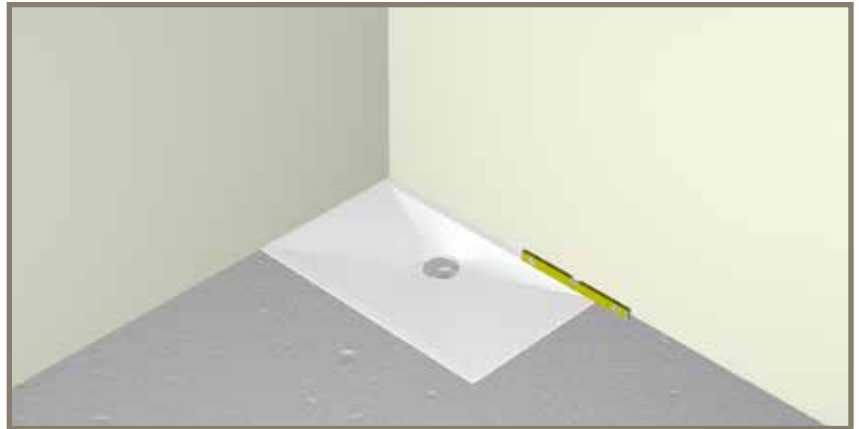

Step 2 > > > > > > >

Once the pan is in the desired location, holding the pan steady, trace the inner circle of the pan. This will mark the location of the drain on the concrete, making it easier to cut out in the next step.

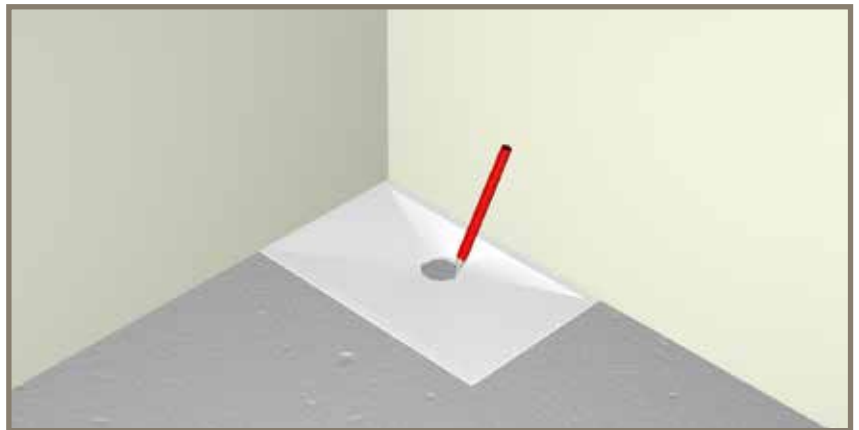

Step 3 > > > > > > >

Using suitable equipment, and proper safety gear, carefully cut a hole that is 10" in diameter. It may be easiest to score the concrete approximately every 1" to 2" inside your perimeter line, to make the removal of the concrete more efficient. Now excavate all of the remaining concrete in the marked area.

Note: If possible, please check or mark location of existing plumbing and electrical to avoid damaging them.



Step 4 > > > > > > >

Place the Fusion pan into place. Once the pan is set to the desired location, note the location of drain and remove enough pipe for the installation of the waste pipe, and drain body.



Step 5 > > > > > > >

Install the drain in accordance with current plumbing and building codes.



Step 6 > > > > > > >

Set the Fusion pan into place and check to make sure the pan is level. This is important to achieve proper drainage. If you notice any rocking or flexing in the pan, you may need to shim or shave areas.

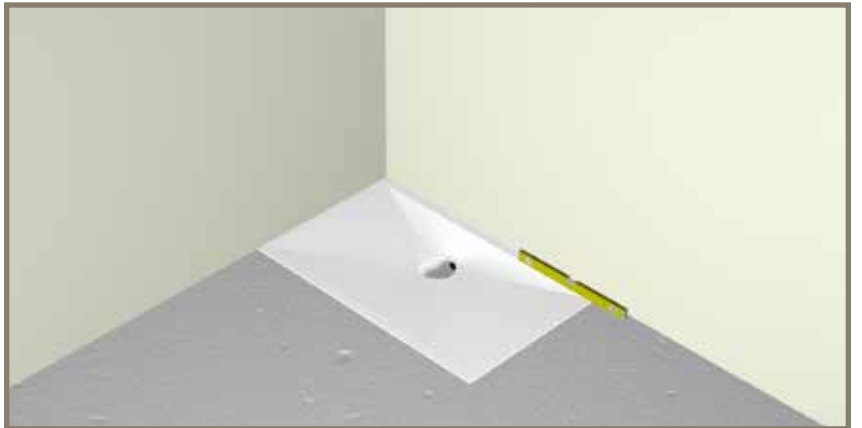

Step 7 > > > > > > >

Important: You must sand the top of the pan lightly with a palm or belt sander to roughen up the surface for proper adhesion of waterproofing.



Step 8 > > > > > > >

To prep for permanent installation, remove the Fusion pan from the surface. Apply a generous amount of construction adhesive to the concrete floor. Place the pan down into position and apply pressure to adhere the pan to the concrete.



Step 9 > > > > > > > >

Again while insuring that your pan has remained level, drill and counter sink holes into the Fusion pan. Using cement anchors, attach the pan. Do not aggressively screw and over tighten, as you may force the Fusion Pan out of level.



Step 10 > > > > > > > >

Using a screed bed, bring the rest of the floor up to the level of the Fusion pan.

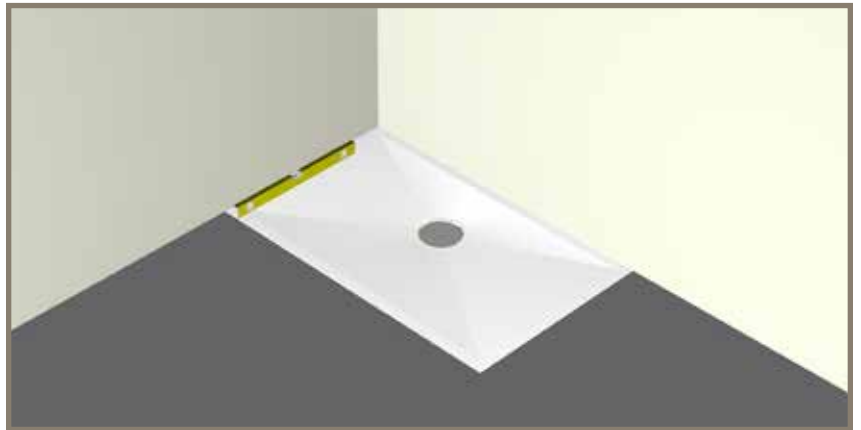

Step 11 > > > > > > > >

Check that the Fusion Pan is level on all four sides.

Fill in any gaps around the perimeter of the pan over 1/8" with latex or acrylic caulk.

Do not use 100% silicone.

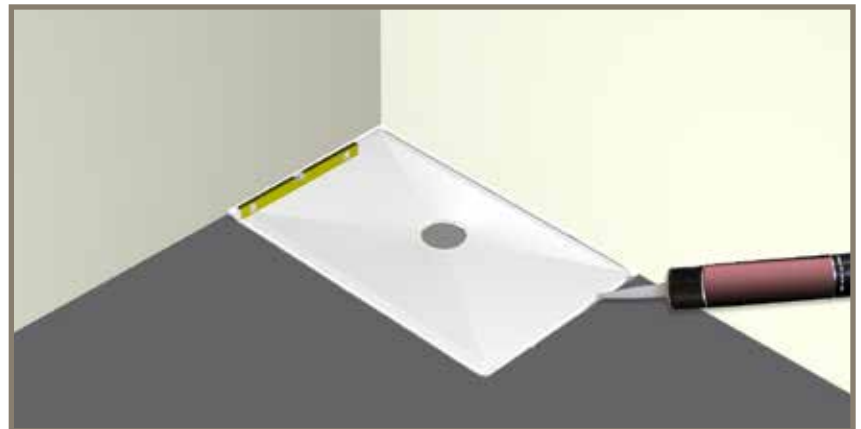

Step 12 > > > > > > > >

You now want to attach the Drain adapter flange to the Fusion Pan. First apply a bead of caulk to the underside of the drain adapter flange. Lightly push the flange into place, and screw it down using the four 3/4" screws provided. Remove any excess caulk that squeezes out.

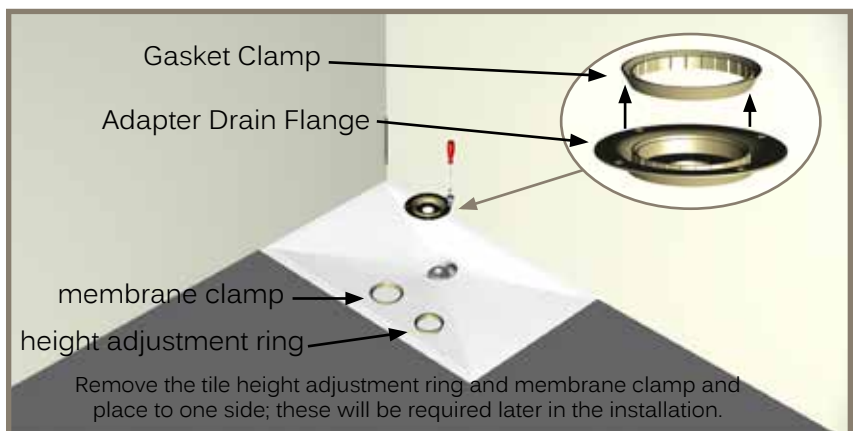

Step 13 > > > > > > >

Make your final connections to the drain. First apply a bead of caulk to the underside of the strainer body. Pass the strainer through the drain adapter flange, and tighten. Make sure connection is snug but do not over tighten.

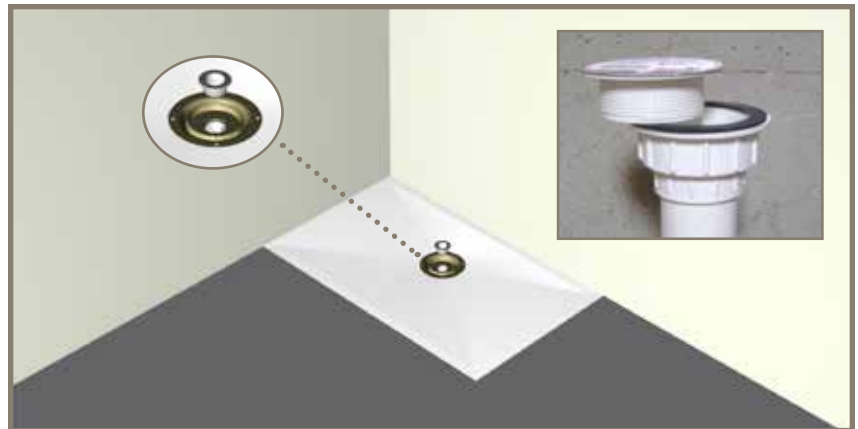

Step 14 > > > > > > >

You will now begin waterproofing the wet room.

BEST PRACTICE: To achieve the best results, we recommend waterproofing the whole room.

Minimum requirements, shown in these instructions, show you that you only have to waterproof the shower zone, which is 6 ½ feet high and about 2 feet outside of the showering area.

Materials needed for wet room waterproofing.



Step 15 > > > > > > >

Begin taping the wetroom floor at the interior corners of the Fusion Pan using the corner pieces of the crack isolation tape provided. Using a paint brush or trowel, slather liquid waterproofing into corner, press piece into place, then apply liquid waterproofing on top. Make sure to smooth out any creases. Repeat for additional corners.



Step 16 > > > > > > >

Using the 5" crack isolation tape provided, cut strips of tape to length, to cover all seams (Corner seams, wall/floor seams, pan/floor joint). Put pieces aside.

If you are creating full wet room, you will need to tape any seams throughout the entire room.

If you are only waterproofing the shower zone, you will only need to tape the seams up to 2 feet outside the shower area.



Step 17 > > > > > > >

Just like you applied the corner pieces, use your cut strips of Crack Isolation Tape to cover all the seams. Again, trowel or paint liquid waterproofing onto seam, press tape into position and coat the top to seal. Make sure to fully cover both sides of the crack isolation tape with the liquid waterproofing product. To make this process more manageable, it is best to work in two foot sections.

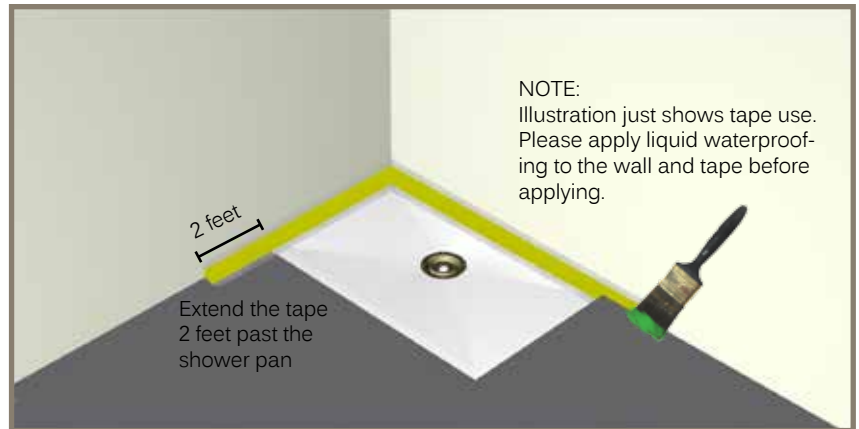

Step 18 > > > > > > >

Using the 5" crack isolation tape. Overlap all seams of cement board used on either the floors or walls. Overlap the seam where the Fusion pan and cement board meet.



Step 19 > > > > > > >

Using the provided precut piece of gasket membrane, slather area where gasket piece will adhered to the drain area. Place over drain adapter flange, making sure to cover all screw holes, and securely press down into flange. Coat top of gasket piece with liquid waterproofing.

Important: Remember to remove the clamping ring prior to placing drain gasket.

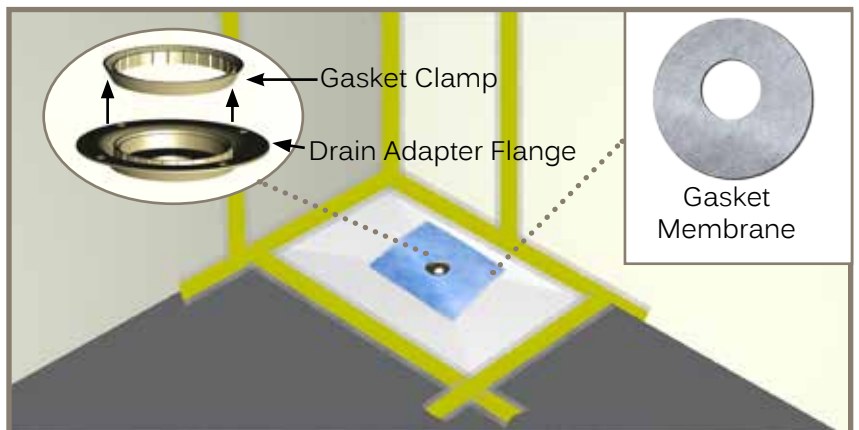

Step 20 > > > > > > >

Now attach the clamping ring. Apply solvent cement to inside of clamping ring. Press firmly into position and allow the solvent to set.

NOTE: Do not allow the solvent cement to come into contact with the membrane

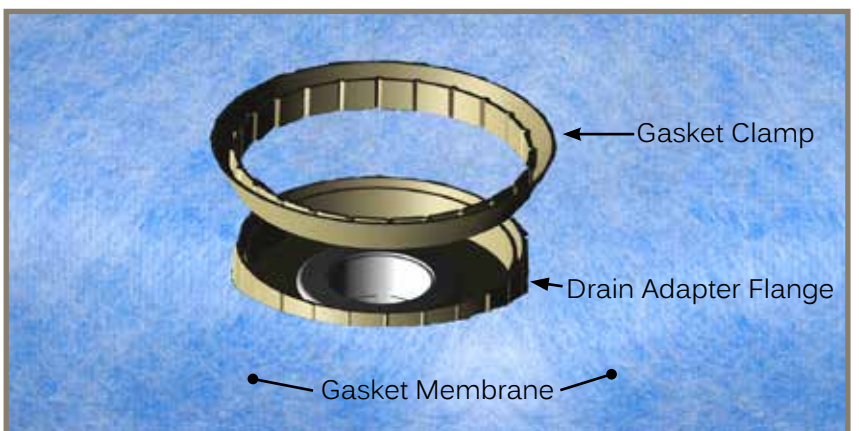

Step 21 > > > > > > >

Begin the application of the liquid waterproofing membrane. Paint a layer of liquid waterproofing over all taped joints. It is easiest to begin with the walls first and then proceed to the floor area. For constant application, use a paint roller to apply waterproofing to all surfaces. Allow the waterproofing to dry for about 4 hours. After first coat is dry, re-coat in the opposite direction. If you rolled up and down for the first coat, roll left to right on the second coat.

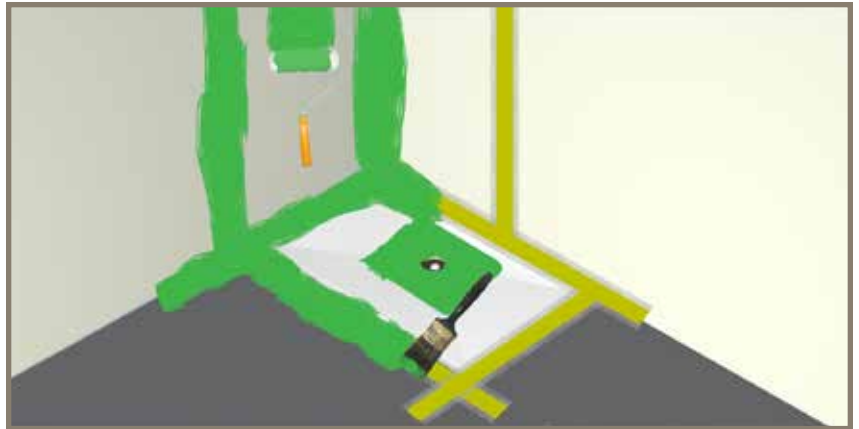

Step 22 > > > > > > >

Apply two coats of liquid waterproofing in opposing directions to achieve 40 mils. (roughly the thickness of a credit card)

Make sure that the "V" section of the gasket clamp is filled with the liquid waterproofing.

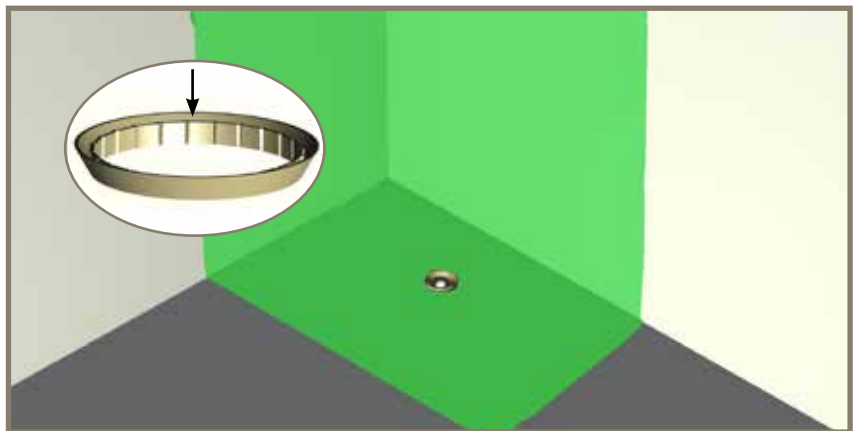

Best Practice > > > > >

To achieve the best results, we recommend waterproofing the whole room.

The waterproofing must cure for at least 12 hours before flood testing.

If flood testing, perform test before tiling.

Use modified thinset when placing the tile.



Step 23 > > > > > > >

In order to set the correct height of the grate frame, you may need to use the height extension ring (see diagram to the right). If the height extension ring is required, it will need to be fixed to the height adjustment ring using solvent cement. The grate frame can now be attached to the height adjustment or extension ring, depending on tile thickness. This is done by using firm pressure to clip the components together; it is a tight fit.

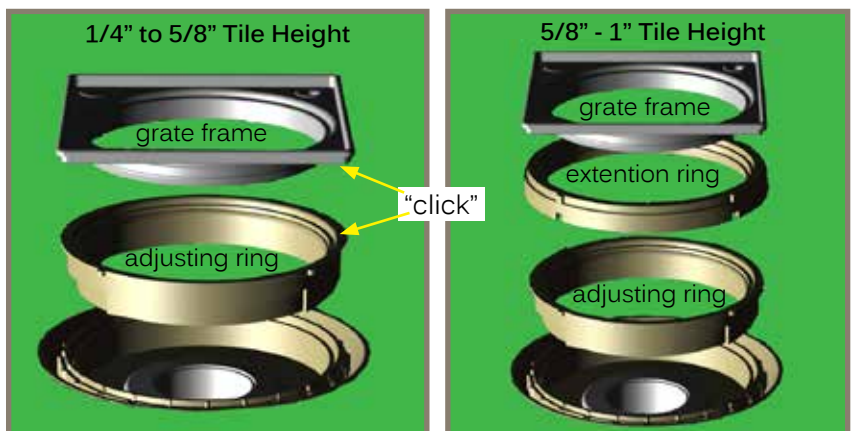

Step 24 > > > > > > >

The height adjustment ring and floor drain must now be fixed together using solvent cement. Because solvent cements sets very rapidly we strongly recommend the adjustment is done "dry" first.

To set the permanent height of the grate frame, place a floor tile beside the frame. Rotate the frame until the height is about 1/16" higher (this accounts for adhesive thickness). Now mark the position of the adjustment ring. This mark shows the final height position. Remove ring, apply solvent cement, and re-align components to your marked position. It is best to hold securely until pieces are fully bonded.

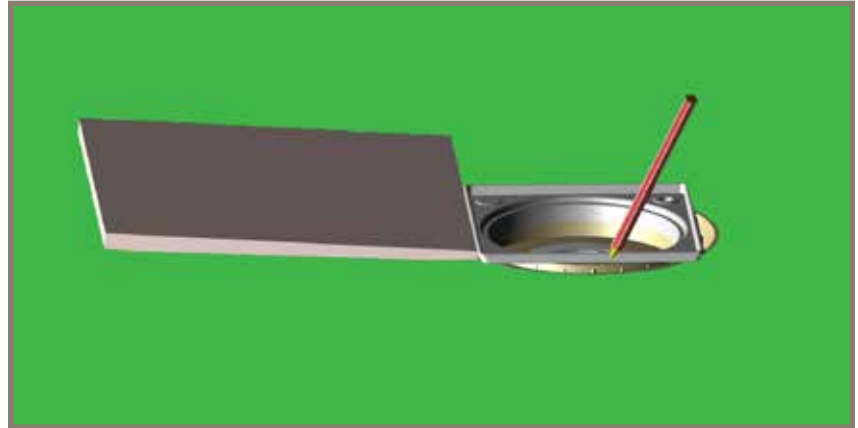

Step 25 > > > > > > >

You are now ready to tile. If you are using large format tiles, they must be cut diagonally and laid to follow the pitch in the Fusion Pan (From the corners of the grate frame to the corners of the Fusion Pan). Apply the tile adhesive, and lay the tiles in a regular pattern.

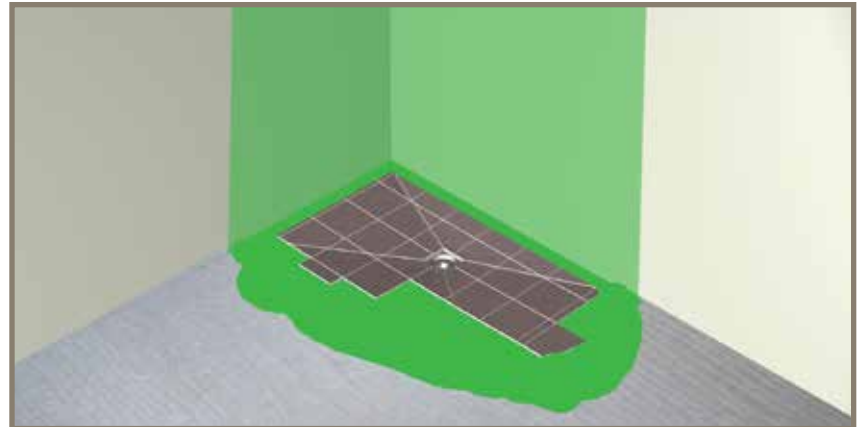

Step 26 > > > > > > >

Once your tiling is complete. Grout the floors and walls. Finalize by adding the drain grate. Your Fusion Pan installation is now complete. Enjoy!

